

CHAUDIÈRE ÉLECTRIQUE "BTH ULTRA" ELECTRIC BOILER
Installation type en Bi-énergie avec valve trois voies
Typical installation in Dual-energy with three way valve

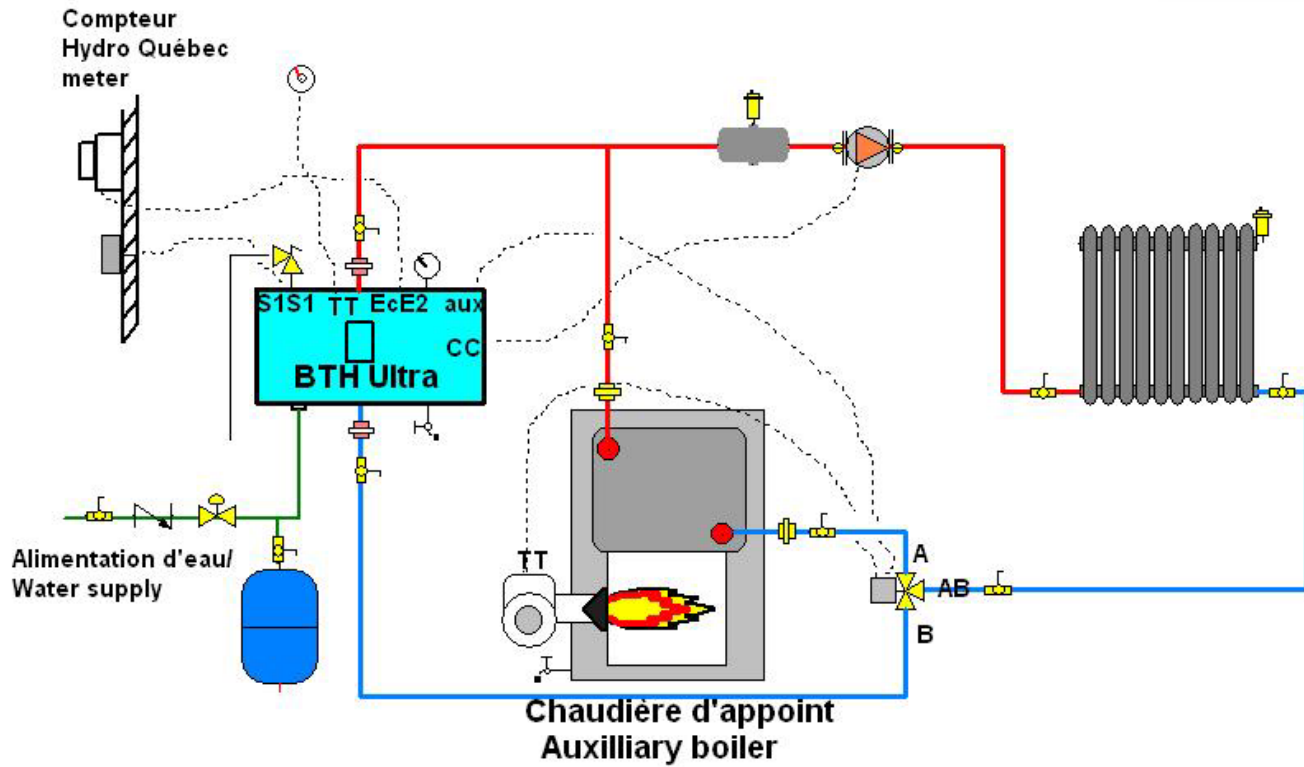

Réducteur pression
Pressure reducer

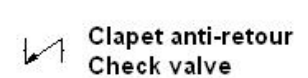
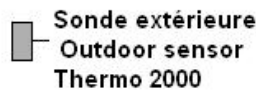
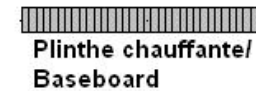
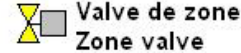
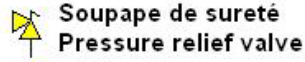
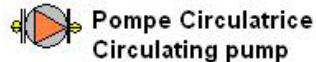
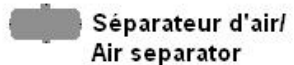
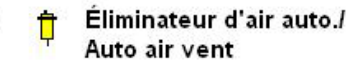

L'installateur est responsable de l'adaptation de ces schémas d'installation en fonction de l'application et des normes en vigueur.
 The person who installs this machine is responsible for adapting this diagram according to the norms in place.