

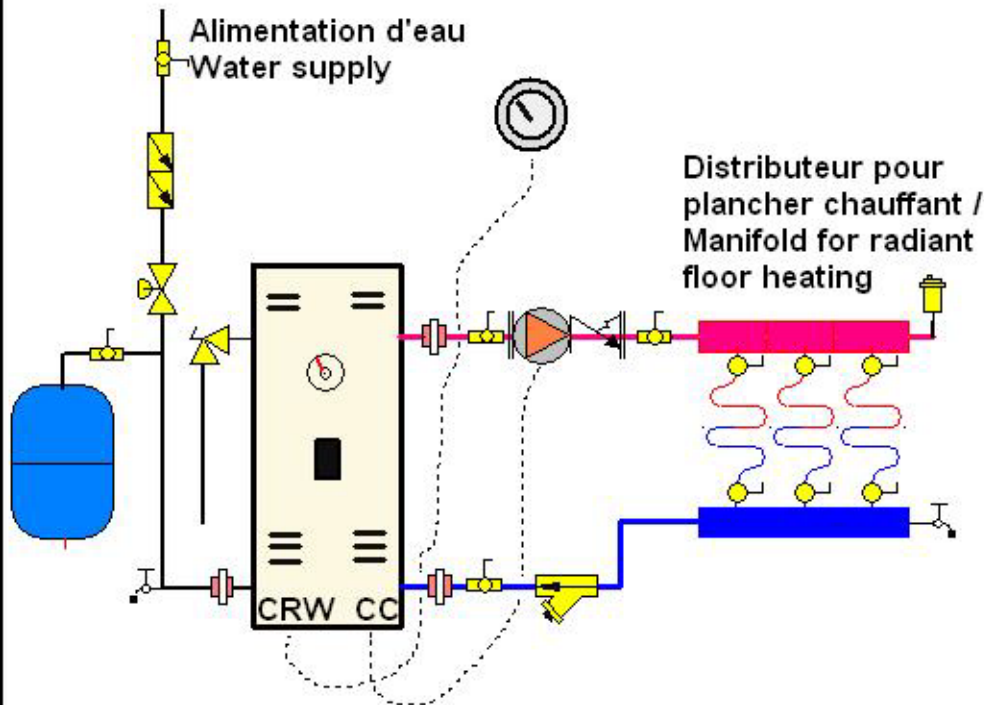









CHAUDIÈRE ÉLECTRIQUE "MINI BTH" ELECTRIC BOILER

LEGENDE / LEGEND

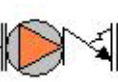

-  Thermostat de pièce ou interrupteurs des robinets de zone / House thermostat or zone valve switches
-  Réservoir d'expansion
Expansion tank
-  Purgeur d'air automatique
Automatic air purger
-  Union
-  Réducteur de pression
Pressure reducer
-  Robinet de service
Maintenance valve
-  Robinet de vidange
Drain valve
-  Soupape de sureté
Pressure relief valve
-  Pompe avec clapet
anti-retour
Pump with check valve
-  Filtre /Strainer

INSTALLATION TYPIQUE SUR PLANCHER CHAUFFANT TYPICAL INSTALLATION ON RADIANT FLOOR SYSTEM



L'installateur est responsable de l'adaptation de ces schémas d'installation en fonction de l'application et des normes en vigueur.
The person who installs this machine is responsible for adapting this diagram according to the norms in place.